

## OT 165/170...240/1A0 4DIMLT2 E

OT 4DIM NFC IP20 Outdoor | DALI-2, AstroDIM, StepDIM, MainsDIM – constant current LED drivers



### Areas of application

- Street and urban lighting
- Industry
- Suitable for outdoor applications in luminaires with IP > 54
- Suitable for use in outdoor luminaires of protection class I and II

### Product family benefits

- 4DIM functionality in one device (StepDIM, AstroDIM, MainsDIM, DALI)
- Very high efficiency
- High surge protection: up to 10 kV (1 pulse) / 8 kV, in protection class I or II
- Low luminous efficacy tolerance through low output current tolerance of  $\pm 3\%$
- Great flexibility due to wide operating temperature range of  $-40...55\text{ }^{\circ}\text{C}$  or  $60\text{ }^{\circ}\text{C}$
- Protection through double isolation between mains input and LED output

### Product family features

- Available with different wattage: 40 W, 60 W, 90 W, 165 W
- Input voltage: 120...277 V (40 W), 220...240 V (60 W, 90 W, 165 W)
- Current output range: 70...1,050 mA
- Flexible current setting with one additional wire (LEDset2)
- AstroDIM for autonomous dimming with five independent levels (astro, time mode)
- Allows for energy saving in twilight phases
- MainsDIM function for dimming via reduction of line voltage amplitude
- Isolated DALI interface for bidirectional telemanagement systems
- Standby power consumption: < 0.5 W
- Constant Lumen Output (CLO)
- Overtemperature protection via external NTC

## Technical data

### Electrical data

Nominal voltage	220...240 V
Input voltage AC	170...264 V <sup>1)</sup>
Nominal current	0.78 A <sup>2)</sup>
Mains frequency	50...60 Hz
Nominal input voltage (SD port)	220...240 V <sup>3)</sup>
Power factor $\lambda$	0.95/0.90 <sup>4)</sup>
Total harmonic distortion	10 % <sup>5)</sup>
Device power loss	13 W <sup>6)</sup>
Inrush current	62 A <sup>7)</sup>
Max. ECG no. on circuit breaker 10 A (B)	5 <sup>8)</sup>
Max. ECG no. on circuit breaker 16 A (B)	8 <sup>8)</sup>
Max. ECG no. on circuit breaker 25 A (B)	14 <sup>8)</sup>
Surge capability (L/N-Ground)	10 kV <sup>9)</sup>
Surge capability (L-N)	6 kV <sup>10)</sup>
Nominal output power	165 W <sup>11)</sup>
ECG efficiency	92 % <sup>12)</sup>
Nominal output voltage	90...285 V <sup>13)</sup>
U-OUT (working voltage)	300 V
Nominal output current	120...1050 mA
Output current tolerance	±3 %
Output ripple current (100 Hz)	15 %
Minimum output current	120 mA <sup>14)</sup>
Galvanic isolation	double/reinforced
Max. no. of ECGs on 16A MCB with EBN-OS	15
Surge capability (SD – Ground)	10 kV <sup>9)</sup>
Surge capability (L/N – SD)	6 kV <sup>10)</sup>

<sup>1)</sup> Permitted voltage range

<sup>2)</sup> At 230 V

<sup>3)</sup> In relation to N / Active: input current > 2.0 mA<sub>pk</sub> / Inactive: input current < 0.5 mA<sub>pk</sub> / Suitable for three phase System only for 220...240 V<sub>AC</sub>

<sup>4)</sup> Minimum/Full load at 230 V/Half load at 230 V

<sup>5)</sup> Max. output power at 230 V<sub>AC</sub>

<sup>6)</sup> Maximum

<sup>7)</sup>  $t_{width} = 330 \mu s$  (measured at 50 % I<sub>peak</sub>)

<sup>8)</sup> Type B

<sup>9)</sup> Single pulse 10kV / 12 Ohm (1.2/50  $\mu s$ )

<sup>10)</sup> @ 2 Ohm, acc. to EN61547

<sup>11)</sup> Partial load 32...165 W / 150 W max. for output currents < 680 mA / Not dimmed

<sup>12)</sup> At full load and 230 V

## Product datasheet

13) 90...242 V for output current >680 mA

14) Physical Minimum Dimming Current 70 mA

### Dimensions & weight

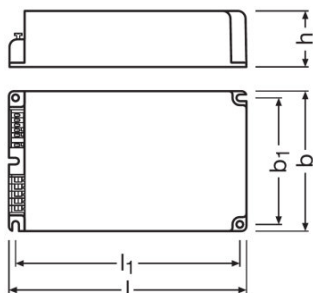

<b>Length</b>	170.0 mm
<b>Width</b>	100.0 mm
<b>Height</b>	40.0 mm
<b>Mounting hole spacing, length</b>	160.0 mm
<b>Mounting hole spacing, width</b>	90.0 mm
<b>Product weight</b>	1100.00 g
<b>Cable cross-section, input side</b>	0.25...2.5 mm <sup>2</sup> <sup>1)</sup>
<b>Cable cross-section, output side</b>	0.2...1.5 mm <sup>2</sup> <sup>2)</sup>
<b>Wire preparation length, input side</b>	10...11 mm <sup>3)</sup>

<sup>1)</sup> Flexible / Solid leads / Equipotential pole only 0.2...1.5 mm<sup>2</sup>

<sup>2)</sup> Flexible / Solid leads

<sup>3)</sup> Equipotential pole 8.5...9.5

### Temperatures & operating conditions

<b>Ambient temperature range</b>	-40...+55 °C
<b>Maximum temperature at tc test point</b>	85 °C <sup>1)</sup>
<b>Max.housing temperature in case of fault</b>	120 °C
<b>Permitted rel. humidity during operation</b>	5...85 %

<sup>1)</sup> Maximum at the T<sub>c</sub>-point

### Lifespan

<b>ECG lifetime</b>	85000 h <sup>1)</sup>
---------------------	-----------------------

<sup>1)</sup> At T<sub>case</sub> = 75°C at T<sub>c</sub> point / 10% failure rate

## Expected Lifetime

Product name				
OT 165/170...240/1A0 4DIMLT2 E	ECG ambient temperature [ta]	55	45	43
	Temperature at tc-point [°C]	85	75	72
	Lifetime [h]	50000 <sup>1)</sup>	85000 <sup>1)</sup>	100000 <sup>1)</sup>

<sup>1)</sup> Max. 10% failure rate at tc max and input voltage 230 V<sub>AC</sub>

## Capabilities

<b>Dimmable</b>	Yes
<b>Dimming interface</b>	4DIM / DALI / StepDIM / AstroDIM / MainsDIM
<b>Dimming range</b>	17...100 % <sup>1)</sup>
<b>Suitable for fixtures with prot. class</b>	I / II
<b>Constant lumen function</b>	Programmable
<b>NTC input</b>	Yes <sup>2)</sup>
<b>Overheating protection</b>	Automatic reversible
<b>Overload protection</b>	Automatic reversible
<b>Short-circuit protection</b>	Automatic reversible
<b>No-load proof</b>	Yes
<b>Max. cable length to lamp/LED module</b>	2.0 m
<b>Number of channels</b>	1

<sup>1)</sup> For  $\geq 700$  mA nominal output current

<sup>2)</sup> Supports 15K, 5 %, NCP18XW153J03RB / Supports 15K, 3 %, NCP15XW153E03RC + 390 Ohm / Supports 10K, 5 %, NCP18XH103J03RB / EPCOS B57423V2473H

## Programmable features

<b>Operating Current</b>	Yes
<b>Tuning Factor</b>	No
<b>Constant Lumen</b>	Yes
<b>Lamp Operating Time</b>	Yes
<b>End of Life</b>	Yes
<b>Thermal Protection</b>	Yes
<b>Driver Guard</b>	No
<b>AstroDIM</b>	Yes
<b>StepDIM</b>	Yes
<b>MainsDIM</b>	Yes
<b>Presence Detection</b>	Yes

## Product datasheet

<b>DALI Settings</b>	Yes
<b>Emergency Mode</b>	Yes
<b>Luminaire Info</b>	No
<b>OEM Key</b>	Yes

## Certificates & standards

<b>Type of protection</b>	IP20 <sup>1)</sup>
<b>Standards</b>	Acc. to EN 61347-1/Acc. to EN 61347-2-13/Acc. to EN 62384/Acc. to EN 55015:2006 + A1:2007 + A2:2009/Acc. to EN 61547/Acc. to IEC 61000-3-2/Acc. to IEC 61000-3-3/Acc. to IEC 62386-101/Acc. to IEC 62386-102/Acc. to IEC 62386-207
<b>Approval marks – approval</b>	CE / ENEC 10 / VDE / VDE-EMC / CQC

<sup>1)</sup> IP Fixture rating > IP54

## Logistical data

<b>Temperature range at storage</b>	-25...80 °C
<b>Commodity code</b>	850440829000

## Wiring Diagram

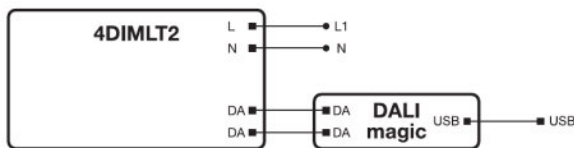

Wiring diagram

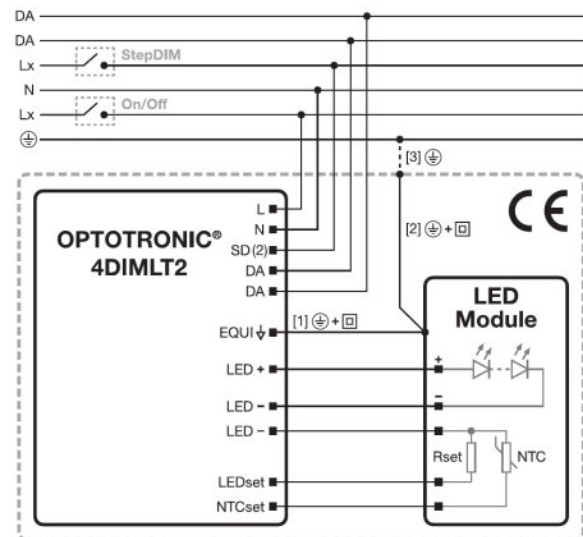

Wiring diagram

## Equipment / Accessories

- DALI magic hardware for configuring 4DIM ECGs necessary

## Product datasheet

- Programmable via Tuner4TRONIC software





---

### Additional product information

- Default output current is 700 mA without any resistor connected to the LEDset port. As soon as the driver detects one time a resistor value within the resistor range of 2.37 kOhm (1050 mA) and 24.9 kOhm (200 mA) for more than 3 s, the driver activates the LEDset2 mode.
- The driver withstands an input voltage of up to 350 Vac for a maximum of two hours. Shut down of output load might occur in case the supply voltage exceeds the declared input voltage range.
- Shut down of output load happens if the input voltage of the load is below the allowed minimum output voltage of the driver. The driver automatically tries to switch on the load cyclically.
- In case the input voltage of the load exceeds the output voltage range of the driver, it automatically reduces the output current to keep the output voltage controlled to the maximum allowed output voltage.
- The driver automatically reduces the output current in case the maximum allowed output power is exceeded.
- The driver automatically adjusts the output voltage to the maximum output voltage if no load is connected and switches off the load after some seconds. Hot-plug of the load or external switching on the secondary side is not allowed.
- The driver is protected against temporary overheating by automatic reduction of the output current down to 30 % and then switches off.
- The EQUI pin shall be connected to the heat sink of the LED module to improve the surge withstand capability of the system and EMI in critical luminaires.
- Several external NTCs are supported for temperature protection of the LED module or luminaire. The type of NTC can be selected in the programming software in the temperature based mode. By default the resistor based mode is activated with following values: start derating: 6.3 kOhm, end derating 5.0 kOhm, shut off: 4.3 kOhm, derating level 50 %.
- The default dimming mode is StepDIM / AstroDIM / DALI (wiring selection) with following values for:- StepDIM: 100 % on, 50 % dimming level if SD port is active, fade time 180 s- AstroDIM: 100 % on, 50 % dimming level, 6 h dimming duration, start of dimming duration 2 h before the middle of the average switched-on time, fade time 180 s
- The constant lumen feature is disabled by default.
- For MainsDIM dimming mode and for 170 Vac input voltage condition the output power should not exceed 85 % of the maximum declared output power.
- For input voltage of 170...190 Vac, the maximum allowed output power is linear limited starting from 100 % at 190 Vac down to 85 % at 170 Vac, except for the 40 W type.
- If any output level is below the physical min level, the physical min level will be used.
- In case the 3DIM and 4DIMLT2 devices are operated on one common control phase connected to SD input the 3DIM devices needs to have a relay as described in the 3DIM application guide.
- The SD port is suitable for three phase systems with 220...240 Vac, for other input voltages only single phase systems are supported.
- For further details please consult the 4DIMLT2 application guide.







---

### Download Data

File	
	Brochures 612095_Overvoltage protection for LED street lighting (EN)
	Brochures Technical Application Guide 4DIMLT2 LED drivers (EN)
	Certificates 685777_CB-Certificate-165W 4DIM
	Certificates 725970_Certificate OT165 4DIM

## Product datasheet

---

	Certificates VDE ENEC Certificate 40043863
	Certificates VDE EMC Certificate 40038827
	Certificates VDE ENEC Certificate 40043863 appendix
	Declarations of conformity 712567_Declaration of Conformity OT 4 DIM LT2 E
	Declarations of conformity EATON(CEAG)-Conformity declaration AA67486_OT165_170-240_1A0_4DIMLT2_E
	Declarations of conformity INOTEC- Conformity declaration AA67486_OT165_170-240_1A0_4DIMLT2_E

---

### Logistical Data

Product code	Product description	Packaging unit (Pieces/Unit)	Dimensions (length x width x height)	Volume	Gross weight
4052899925212	OT 165/170...240/1A0 4DIMLT2 E	Shipping carton box 10	303 mm x 285 mm x 205 mm	17.70 dm <sup>3</sup>	11637.00 g

---

The mentioned product code describes the smallest quantity unit which can be ordered. One shipping unit can contain one or more single products. When placing an order, for the quantity please enter single or multiples of a shipping unit.

---

### Disclaimer

Subject to change without notice. Errors and omission excepted. Always make sure to use the most recent release.